



## Heyco® Quick Connect Terminals

See pages 8-13 & 8-14 for mating Quick Connect Females.

For Heyco Applicators, see page 8-59

### Male Terminal Tabs - .032 gauge

- All terminals feature a **rectangular “locking tab”** in center for added **strain relief** and **support** when inserted into Female connector.
- Heyco Terminals meet all your application needs with **solder**, **crimp**, and **dual male** connections.
- For schematic drawings see opposite page.
- DFARS Compliant

Crimp?	Ref Dwg	PART DATA			PART NO.	APPLICATION TOOLING*				
		Overall Length in.	AWG Range	Material		Die**	Feeds	Crimp Punch	Anvil	
<b>Solder Connection Tabs</b>										
No	4810	.65	Short Solder	Brass Tin-Pl	<b>4810</b> <b>4811</b>	-	Bulk	-	-	
	4833	.72	Solder	Brass	<b>4833</b>	-	Right to Left	-	-	
	8211	.73	Solder	Brass	<b>8211</b>	-	Bulk	-	-	
	4800	.81	Solder	Brass Tin-Pl	<b>4800</b> <b>4801</b>	-	Right to Left	-	-	
Yes†	8044	1.12	Solder	Brass	<b>8044</b>	-	Bulk	-	-	
	8040	1.61	Solder	Brass	<b>8040</b>	-	Bulk	-	-	
<b>Crimp Connection Tabs</b>										
Yes	4836	.64	90° Angle Crimp 18-16	Brass	<b>4836</b>	0624	Right to Left	OK24	OK25	
	4838	.71	26-18	Brass	<b>4838</b>	4838UXX5	Left to Right	C458	C463	
	4820	.81	18-16	Brass Tin-Pl	<b>4820</b> <b>4821</b>	-	Bulk	-	-	
				Brass Tin-Pl	<b>4834</b> <b>4835</b>	4834UXX5 4835UXX6	Left to Right	C460	C465	
<b>Dual Connection Tabs</b>										
No	4822	.47	60° Angle Tab-Dual	Tin-Pl	<b>4822</b>	-	Bulk	-	-	
	4830	.83	Dual	Brass Tin-Pl	<b>4830</b> <b>4829</b>	-	Bulk	-	-	

\* Heyco high volume Application Tooling, designed for 3-5 ton presses - see page 8-59.  
Heyco Mini Applicators, designed for 1.5-3 ton bench top presses, are available for Part Nos. 4834, 4835 & 4848 only. See page 8-59.

\*\* “XX” represents Wire Gauge. Please specify Wire Gauge when ordering.

† Hook crimp located at the quick connect tab end of Terminal

Quick Specs

Materials

Alloy 260 Brass (70% Cu, 30% Zn. Higher Cu content resists dezincification)

Tin-Pl = Brass, Tin plated before or after stamping

# Heyco® Quick Connect Terminals

Male Terminal Tabs - .032 gauge – Schematic Drawings

## Solder Connection Tabs

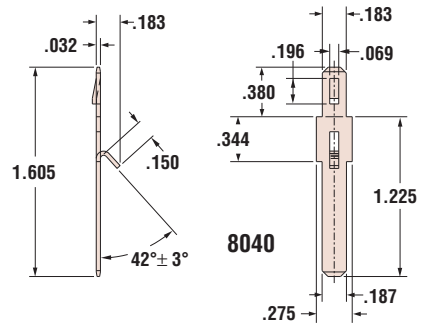
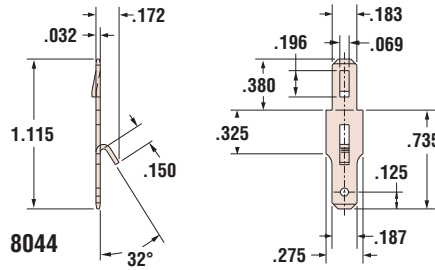
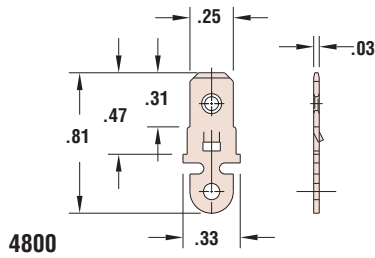
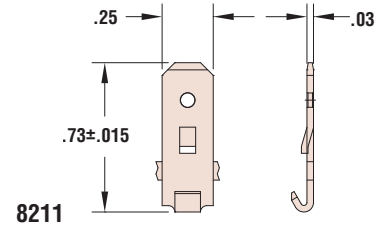
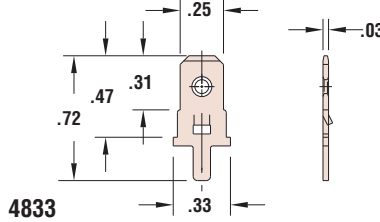
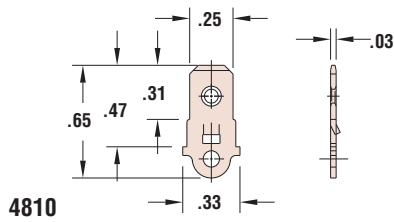

## Crimp Connection Tabs

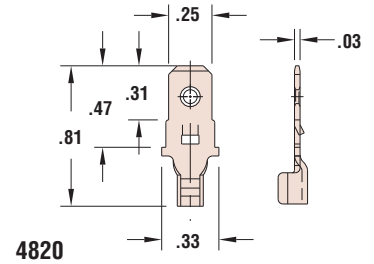
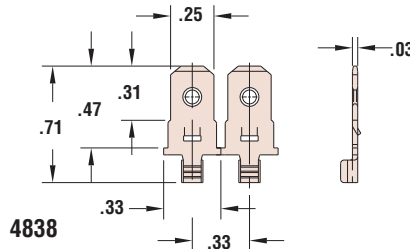
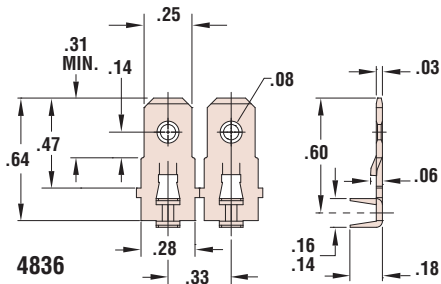

## Dual Connection Tabs

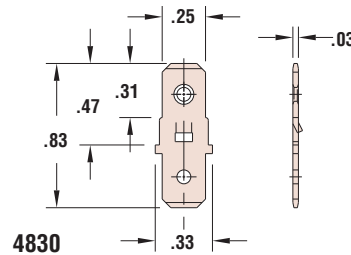
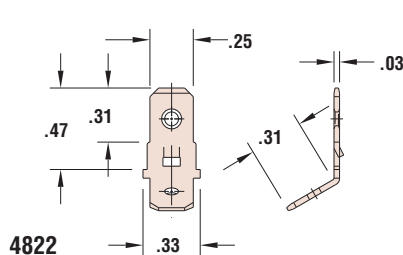

Materials

Alloy 260 Brass (70% Cu, 30% Zn. Higher Cu content resists dezincification)

Tin-Pl = Brass, Tin plated before or after stamping

Quick  
Specs